



Round, square and rectangular tables with conical stainless steel legs, available in a series of woods, marbles and matt or polish lacquers.

Used materials

Structure:

1. Steel conic piping legs in the finishes: white or antrachite varnished, polished chrome, or brass
2. Metal joint
3. Undertop in laser-cut and folded sheet metal, white or antrachite varnished

Top:

4. Marble slab in black Marquinia, Emperador or white Calacatta; or wood particle boards panel veneered in the finishes: Canaletto walnut, natural oak, wengè stained oak, teak, briarwood

Feet:

5. Black plastic

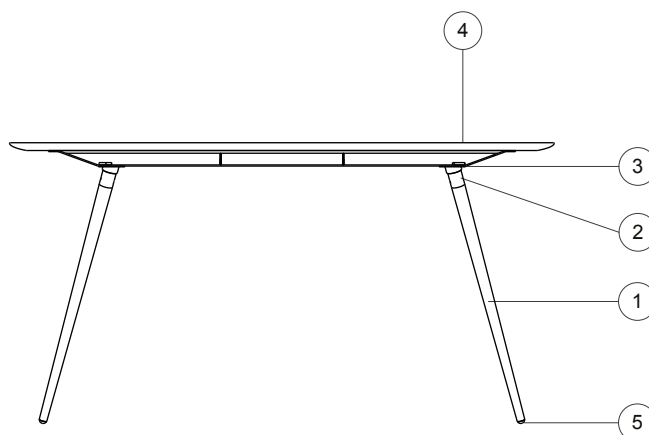

Dimensions

STY1

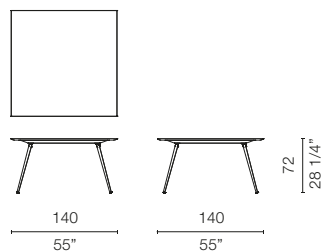

STY2

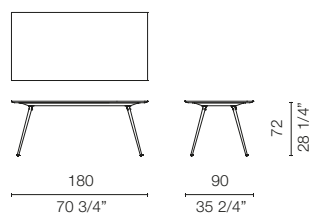

STY3

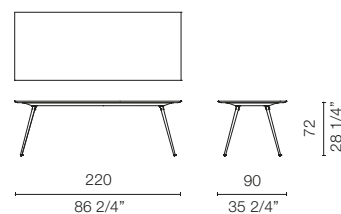

STY4

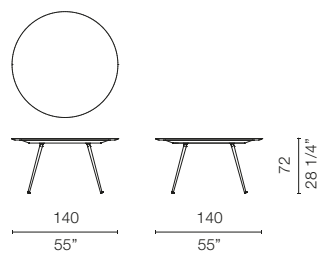

STY5

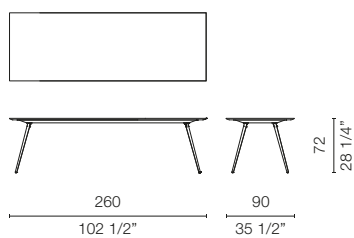

STY6

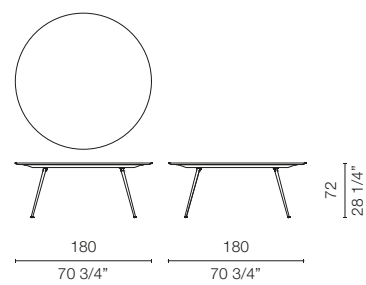

STY7A

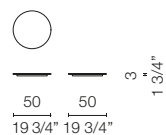

STY7B

